

TECHNICAL MANUAL

888-2509-005

3DX-25/3DX-50 AMC+

Amplitude Modulation Companding Plus

3DX-25/3DX-50 AMC+
Amplitude Modulation Companding Plus



T.M. No. 888-2509-005

Printed: 20Jul2012

Rev.D

© Copyright Harris Corporation 2011, 2012
All rights reserved

Manual Revision History

3DX-25/3DX-50 AMC+ Amplitude Modulation Companding Technical Manual

REV.	DATE	ECN	Pages Affected
Preliminary			Created
0			Review Copy to Service, Engineering, & Safety
A	18Oct2011	P51291	Release Rev. A
B	24Oct2011	P51317	Revised Title Page, MRH-1, and Section 4.2.6
C	11Jan2012	P51870	Revised Title Page, MRH-1 & Page 2-5
D	20Jul2012	P53390	Revised Title Page, MRH-1 & Page 2-10

Technical Assistance

Technical and troubleshooting assistance for HARRIS Transmission products is available from HARRIS Field Service (factory location: Quincy, Illinois, USA) during normal business hours (8:00 AM - 5:00 PM Central Time). Telephone **+1-217-222-8200** to contact the Field Service Department; FAX **+1-217-221-7086**; or E-mail questions to tsupport@harris.com.

Emergency service is available 24 hours a day, seven days a week, by telephone only.

Online assistance, including technical manuals, white papers, software downloads, and service bulletins, are available at <http://www.broadcast.harris.com> (from there, click on *Customer Support Portal* under the *Services & Support* tab dropdown menu).

Address written correspondence to Field Service Department, HARRIS Broadcast Communications Division, P.O. Box 4290, Quincy, Illinois 62305-4290, USA. For other global service contact information, please visit: <http://www.broadcast.harris.com/contact>.

NOTE: For all service and parts correspondence, you will need to provide the Sales Order number, as well as the Serial Number for the transmitter or part in question. For future reference, record those numbers here: _____/_____

Please provide these numbers for any written request, or have these numbers ready in the event you choose to call regarding any Service, or Parts requests. For warranty claims it will be required, and for out of warranty products, this will help us to best identify what specific hardware was shipped.

Replaceable Parts Service

Replacement parts are available from HARRIS Service Parts Department 7:00 AM to 7:00 PM Central Time, Monday through Friday, and 8:00 AM to 1:00 PM Central Time on Saturday. Telephone **+1-217-222-8200** or email servicepartsreq@harris.com to contact the Service Parts Dept.

Emergency replacement parts are available by telephone only, 24 hours a day, seven days a week by calling +1-217-222-8200.

Unpacking

Carefully unpack the equipment and perform a visual inspection to determine if any apparent damage was incurred during shipment. Retain the shipping materials until it has been verified that all equipment has been received undamaged. Locate and retain all PACKING CHECK LISTS. Use the PACKING CHECK LIST to help locate and identify any components or assemblies which are removed for shipping and must be reinstalled. Also remove any shipping supports, straps, and packing materials prior to initial turn on.

Returns And Exchanges

No equipment can be returned unless written approval and a Return Authorization is received from HARRIS Broadcast Communications Division. Special shipping instructions and coding will be provided to assure proper handling. Complete details regarding circumstances and reasons for return are to be included in the request for return. Custom equipment or special order equipment is not returnable. In those instances where return or exchange of equipment is at the request of the customer, or convenience of the customer, a restocking fee will be charged. All returns will be sent freight prepaid and properly insured by the customer. When communicating with HARRIS Broadcast Communications Division, specify the HARRIS Order Number or Invoice Number.

⚠ WARNING:
THE CURRENTS AND VOLTAGES IN THIS EQUIPMENT ARE DANGEROUS. PERSONNEL MUST AT ALL TIMES OBSERVE SAFETY WARNINGS, INSTRUCTIONS AND REGULATIONS.

This manual is intended as a general guide for trained and qualified personnel who are aware of the dangers inherent in handling potentially hazardous electrical/electronic circuits. It is not intended to contain a complete statement of all safety precautions which should be observed by personnel in using this or other electronic equipment.

The installation, operation, maintenance and service of this equipment involves risks both to personnel and equipment, and must be performed only by qualified personnel exercising due care. HARRIS CORPORATION shall not be responsible for injury or damage resulting from improper procedures or from the use of improperly trained or inexperienced personnel performing such tasks. During installation and operation of this equipment, local building codes and fire protection standards must be observed.

The following National Fire Protection Association (NFPA) standards are recommended as reference:

- Automatic Fire Detectors, No. 72E
- Installation, Maintenance, and Use of Portable Fire Extinguishers, No. 10
- Halogenated Fire Extinguishing Agent Systems, No. 12A

⚠ WARNING:
ALWAYS DISCONNECT POWER BEFORE OPENING COVERS, DOORS, ENCLOSURES, GATES, PANELS OR SHIELDS. ALWAYS USE GROUNDING STICKS AND SHORT OUT HIGH VOLTAGE POINTS BEFORE SERVICING. NEVER MAKE INTERNAL ADJUSTMENTS, PERFORM MAINTENANCE OR SERVICE WHEN ALONE OR WHEN FATIGUED.

Do not remove, short-circuit or tamper with interlock switches on access covers, doors, enclosures, gates, panels or shields. Keep away from live circuits, know your equipment and don't take chances.

⚠ WARNING:
IN CASE OF EMERGENCY ENSURE THAT POWER HAS BEEN DISCONNECTED.

⚠ WARNING:
IF OIL FILLED OR ELECTROLYTIC CAPACITORS ARE UTILIZED IN YOUR EQUIPMENT, AND IF A LEAK OR BULGE IS APPARENT ON THE CAPACITOR CASE WHEN THE UNIT IS OPENED FOR SERVICE OR MAINTENANCE, ALLOW THE UNIT TO COOL DOWN BEFORE ATTEMPTING TO REMOVE THE DEFECTIVE CAPACITOR. DO NOT ATTEMPT TO SERVICE A DEFECTIVE CAPACITOR WHILE IT IS HOT DUE TO THE POSSIBILITY OF A CASE RUPTURE AND SUBSEQUENT INJURY.

TREATMENT OF ELECTRICAL SHOCK

1. IF VICTIM IS NOT RESPONSIVE FOLLOW THE A-B-C'S OF BASIC LIFE SUPPORT.
PLACE VICTIM FLAT ON HIS BACK ON A HARD SURFACE

(A) AIRWAY

IF UNCONSCIOUS,
OPEN AIRWAY

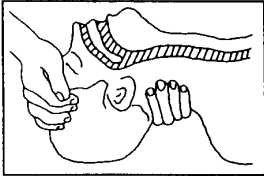

LIFT UP NECK
PUSH FOREHEAD BACK
CLEAR OUT MOUTH IF NECESSARY
OBSERVE FOR BREATHING

CHECK
CAROTID PULSE

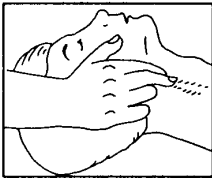

IF PULSE ABSENT,
BEGIN ARTIFICIAL
CIRCULATION

(B) BREATHING

IF NOT BREATHING,
BEGIN ARTIFICIAL BREATHING

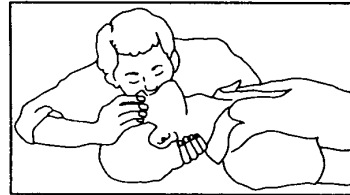

TILT HEAD
PINCH NOSTRILS
MAKE AIRTIGHT SEAL
4 QUICK FULL BREATHS
REMEMBER MOUTH TO MOUTH
RESUSCITATION MUST BE
COMMENCED AS SOON AS POSSIBLE

(C) CIRCULATION

DEPRESS STERNUM 1 1/2 TO 2 INCHES

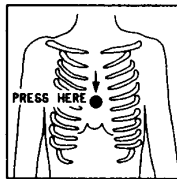

APPROX. RATE
OF COMPRESSIONS { ONE RESCUER
--80 PER MINUTE { 15 COMPRESSIONS
2 QUICK BREATHS

APPROX. RATE
OF COMPRESSIONS { TWO RESCUERS
--60 PER MINUTE { 5 COMPRESSIONS
1 BREATH

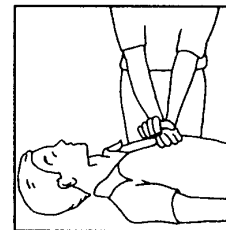

NOTE: DO NOT INTERRUPT RHYTHM OF COMPRESSIONS
WHEN SECOND PERSON IS GIVING BREATH

CALL FOR MEDICAL ASSISTANCE AS SOON AS POSSIBLE.

2. IF VICTIM IS RESPONSIVE.
- A. KEEP THEM WARM
 - B. KEEP THEM AS QUIET AS POSSIBLE
 - C. LOOSEN THEIR CLOTHING
 - D. A RECLINING POSITION IS RECOMMENDED

FIRST-AID

Personnel engaged in the installation, operation, maintenance or servicing of this equipment are urged to become familiar with first-aid theory and practices. The following information is not intended to be complete first-aid procedures, it is a brief and is only to be used as a reference. It is the duty of all personnel using the equipment to be prepared to give adequate Emergency First Aid and there by prevent avoidable loss of life.

Treatment of Electrical Burns

1. Extensive burned and broken skin
 - a. Cover area with clean sheet or cloth. (Cleanest available cloth article.)
 - b. Do not break blisters, remove tissue, remove adhered particles of clothing, or apply any salve or ointment.
 - c. Treat victim for shock as required.
 - d. Arrange transportation to a hospital as quickly as possible.
 - e. If arms or legs are affected keep them elevated.

NOTE:

If medical help will not be available within an hour and the victim is conscious and not vomiting, give him a weak solution of salt and soda: 1 level teaspoonful of salt and 1/2 level teaspoonful of baking soda to each quart of water (neither hot or cold). Allow victim to sip slowly about 4 ounces (a half of glass) over a period of 15 minutes. Discontinue fluid if vomiting occurs. (Do not give alcohol.)

2. Less severe burns - (1st & 2nd degree)
 - a. Apply cool (not ice cold) compresses using the cleanest available cloth article.
 - b. Do not break blisters, remove tissue, remove adhered particles of clothing, or apply salve or ointment.
 - c. Apply clean dry dressing if necessary.
 - d. Treat victim for shock as required.
 - e. Arrange transportation to a hospital as quickly as possible.
 - f. If arms or legs are affected keep them elevated.

REFERENCE:

ILLINOIS HEART ASSOCIATION
AMERICAN RED CROSS STANDARD FIRST AID AND PERSONAL SAFETY
MANUAL (SECOND EDITION)

Guide to Using Harris Parts List Information

The Harris Replaceable Parts List Index portrays a tree structure with the major items being leftmost in the index. The example below shows the Transmitter as the highest item in the tree structure. If you were to look at the bill of materials table for the Transmitter you would find the Control Cabinet, the PA Cabinet, and the Output Cabinet. In the Replaceable Parts List Index the Control Cabinet, PA Cabinet, and Output Cabinet show up one indentation level below the Transmitter and implies that they are used *in* the Transmitter. The Controller Board is indented one level below the Control Cabinet so it will show up in the bill of material for the Control Cabinet. The tree structure of this same index is shown to the right of the table and shows indentation level versus tree structure level.

Example of Replaceable Parts List Index and equivalent tree structure:

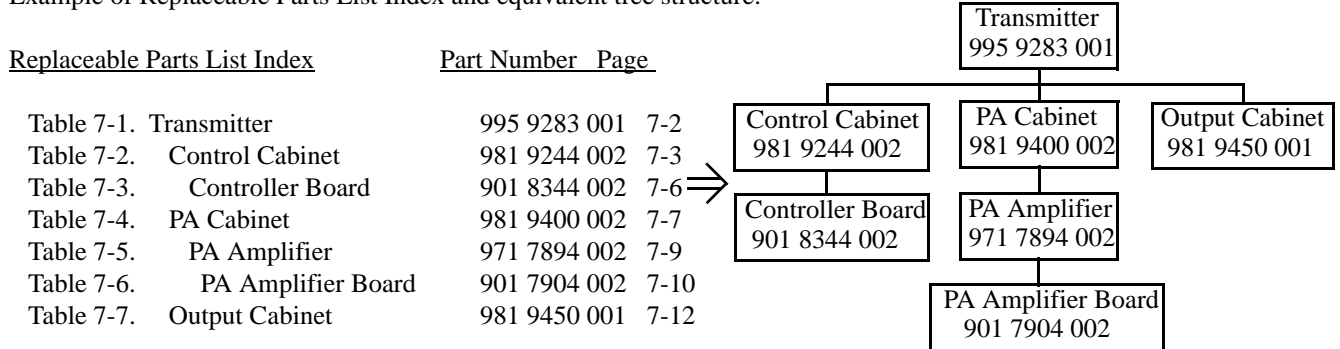

The part number of the item is shown to the right of the description as is the page in the manual where the bill for that part number starts. Each table headings is in the format of; **Table #-#. ITEM NAME - HARRIS PART NUMBER** - this line gives the information that corresponds to the Replaceable Parts List Index entry;

Inside the actual tables, four main headings are used:

- **HARRIS P/N** column gives the Harris part number (usually in ascending order);
- **DESCRIPTION** column gives a 25 character or less description of the part number;
- **Qty UM** column notes the quantity and unit of measure of the item;
- **REF. SYMBOLS/EXPLANATIONS** column 1) gives the reference designators for the item (i.e., C001, R102, etc.) that corresponds to the number found in the schematics (C001 in a bill of material is equivalent to C1 on the schematic) or 2) gives added information or further explanation (i.e., “Used for 208V operation only,” or “Used for HT 10LS only,” etc.).

NOTE: Inside the individual tables some standard conventions are used:

- A # symbol in front of a component such as #C001 under the REF. SYMBOLS/EXPLANATIONS column means that this item is used on or with C001 and is not the actual part number for C001.
- In the ten digit part numbers, if the last three numbers are 000, the item is a part that Harris has purchased and has not manufactured or modified. If the last three numbers are other than 000, the item is either manufactured by Harris or is purchased from a vendor and modified for use in the Harris product.
- The first three digits of the ten DIGIT part number tell which family the part number belongs to - for example, all electrolytic (can) capacitors will be in the same family (524 xxxx 000). If an electrolytic (can) capacitor is found to have a 9xx xxxx xxx part number (a number outside of the normal family of numbers), it has probably been modified in some manner at the Harris factory and will therefore show up farther down into the individual parts list (because each table is normally sorted in ascending order). Most Harris made or modified assemblies will have 9xx xxxx xxx numbers associated with them.

The term “SEE HIGHER LEVEL BILL” in the description column implies that the reference designated part number will show up in a bill that is higher in the tree structure. This is often the case for components that may be frequency determinant or voltage determinant and are called out in a higher level bill structure that is more customer dependent than the bill at a lower level.

Table of Contents

Section 1 Introduction

Scope And Purpose	1-1
Equipment Description	1-1
AMC+ Concept.	1-2
Graphical Representation.	1-3
Power Savings	1-4
Conclusion	1-5
Block Diagram	1-5
Specifications	1-5
Reduction Accuracy	1-5
Squarewave Overshoot.	1-5
AMC+ Operation	1-5
Audio Input Level.	1-5
Audio Input Impedance	1-5
Audio Input Connector.	1-6

Section 2 Installation

Introduction.	2-1
Returns And Exchanges	2-1
Unpacking	2-1
Installation.	2-2
Test Equipment Needed for Installation.	2-2
Mechanical Installation.	2-2
Initial Settings	2-4
Enhanced External I/O Board Configuration	2-4
AMC+ Board Configuration.	2-6
Select AMC+ Curve (S1)	2-7
AMC+ Setup for 3DX Transmitters	2-10
Initial Turn On	2-13
AMC+ Verification	2-13

Section 3 Operation

Introduction.	3-1
Operation.	3-1
AMC+ Bypass	3-1
AMC+ On.	3-1
Controls and Indicators.	3-2

Section 4 Theory of Operation

Introduction.	4-1
AMC+ OFF Mode of Operation.	4-1
AMC+ ON Mode of Operation	4-1
Detailed Circuit Description	4-1
Audio Input	4-1
A/D Converter - Look Up Table.	4-2
D/A Converter	4-2
Phase Delay	4-2
Carrier Synchronization	4-2
Remote Control	4-3
Audio+DC Output Driver.	4-3
Power Supplies.	4-3

Section 5 Maintenance and Alignments

Introduction.	5-1
Purpose	5-1
AMC+ Phase Delay (S3)	5-1
AMC+ Alignment for DX Transmitters	5-1
AMC+ Verification Procedure	5-1

Section 6 Troubleshooting

Introduction.	6-1
Troubleshooting Hierarchy.	6-1
Power Supplies.	6-1
Carrier Sync	6-1
Jumper Settings	6-1
Audio Input/Output	6-1
ACC bypass mode.	6-2
Component Table	6-2

Section 7 Parts List

Parts List	7-1
----------------------	-----

Table of Contents (Continued)

Section 1

Introduction

1

1.1 Scope And Purpose

This technical manual contains the information necessary to install and maintain the AMC+ Amplitude Modulation Companding system for the Harris 3DX-25 and 3DX-50 AM transmitters. The manual is conveniently divided into the following sections:

- SECTION I INTRODUCTION/SPECIFICATIONS. Provides general manual layout equipment description, block diagrams, description and specifications.
- SECTION II INSTALLATION/INITIAL TURN-ON. Provides detailed installation procedures and initial turn on instructions.
- SECTION III OPERATORS GUIDE. Provides a description of the normal operation of the unit using controls and indicators.
- SECTION IV OVERALL SYSTEM THEORY. Provides block diagram and detailed theory of operation of the controller unit and various sections that apply to the overall system.
- SECTION V MAINTENANCE/ALIGNMENTS. Provides board alignment procedures.
- SECTION VI TROUBLESHOOTING. Provides general information for troubleshooting.
- SECTION VII PARTS LIST. Provides a parts list for the entire assembly.

1.2 Equipment Description

The following technical manual is intended to familiarize the reader with the Harris Amplitude Modulation Companding (AMC+) system for Direct Digital Drive (3DX) transmitters. Even though 3DX transmitters are already highly efficient (overall 83% or better), AMC+ may be used to further reduce operating costs.

AMC+ may also be referred to as Modulation Dependent Carrier Control (MDCC), Dynamic Carrier Control (DCC), or Dynamic Amplitude Modulation (DAM).

An optional *Enhanced External I/O Package*, Harris Part Number 992 7285 061, is required to install the AMC+ board in a 3DX transmitter. The Enhanced External I/O board replaces the standard External I/O board in the 3DX-25/3DX-50 and provides an AES/EBU audio input in addition to the analog inputs.

The Enhanced External I/O may already be installed in the transmitter, or delivered as a field upgradeable kit including the AMC+ board.

The *AMC+/ACC+ and Enhanced External I/O Package*, Harris Part Number 992 7285 064 may already be installed in the transmitter, or be delivered as a field upgradeable kit.

1.2.1 AMC+ Concept

AMC+, which stands for Amplitude Modulation Compadding, is a method of Adaptive Carrier Control (ACC). Harris offers two methods of Adaptive Carrier Control, ACC+ and AMC+. The AMC+ concept is very simple, however, in understanding the operation and benefits of AMC+, it may be easier to first consider a transmitter's typical modulation scheme and the ACC+ method. To illustrate how power savings are achieved, without either ACC+ or AMC+ carrier control, regardless if the audio input is increased or decreased, the carrier power of a normally modulated transmitter will remain at full output. And, for example, if the transmitter's audio input is reduced and modulation is only 50%, then carrier power is wasted. The ACC+ method decreases the carrier power during low levels of input audio (modulation), thus resulting in power savings.

Where AMC+ differs from ACC+, an AMC+ enabled transmitter provides full carrier power during periods of no audio, and reduces the transmitter's carrier power with increases in audio input and/or modulation. Both methods result in power savings, however, AMC+ allows for power savings while the transmitter is modulated, thus providing full carrier power during periods of no audio.

For example, with AMC+ and no audio, carrier is full power. Since AMC+ reduces the carrier power starting at 10% modulation until 100% modulation, starting at 10% modulation, as the transmitter is modulated to 100%, the carrier level is also reduced to 3 dB, or half power.

In theory, AMC+, dependent upon the time constant of the receiver's AGC and the program material, decreases the possibility of a slight increase in the noise floor of the receiver during periods of low modulation levels (as the receiver's AGC opens up).

Therefore, AMC+ is a form of carrier control that is dependent upon the audio input level and designed to reduce operating costs.

EAMC+ is a carrier reduction curve similar in direction and reduction to AMC+, used when a higher carrier power from the transmitter is desired. EAMC+ allows for a +1.76 dB increase in normal full carrier with no audio present. See Figure 1-1 on page 1-4, for details.

1.2.1.1 Graphical Representation

Refer to the graph Figure 1-1 on page 1-4 in this section.

- a. The horizontal axis displays Audio Input (in dBm) with respect to 100% modulation. On the extreme right side of the scale 0dBm = the audio input level that creates 100% modulation. Typically this level is +10dBm.
- b. The vertical axis displays Carrier Level (in dB) with respect to normal carrier. On the extreme top side of the scale is full carrier at +3dB.
- c. For a normal 3DX transmitter in AMC mode, the operation would be described by a single straight line at 0dB. 0dB equals 0% modulation and full carrier level.
- d. The other line on this graph represents EAMC+.

The amount of carrier reduction is fixed at -3 dB, corresponding with the set of horizontal lines in the center of the graph.

The point at which AMC+ starts is 10% to 100% modulation. This corresponds with the set of downward-sloping lines towards the right-hand side of the graph.

The carrier level versus audio level is then described by this single function. The user can select the EAMC+ function via jumper-enabled remote command input, which duplicates the AMC+ function, but at a higher level.

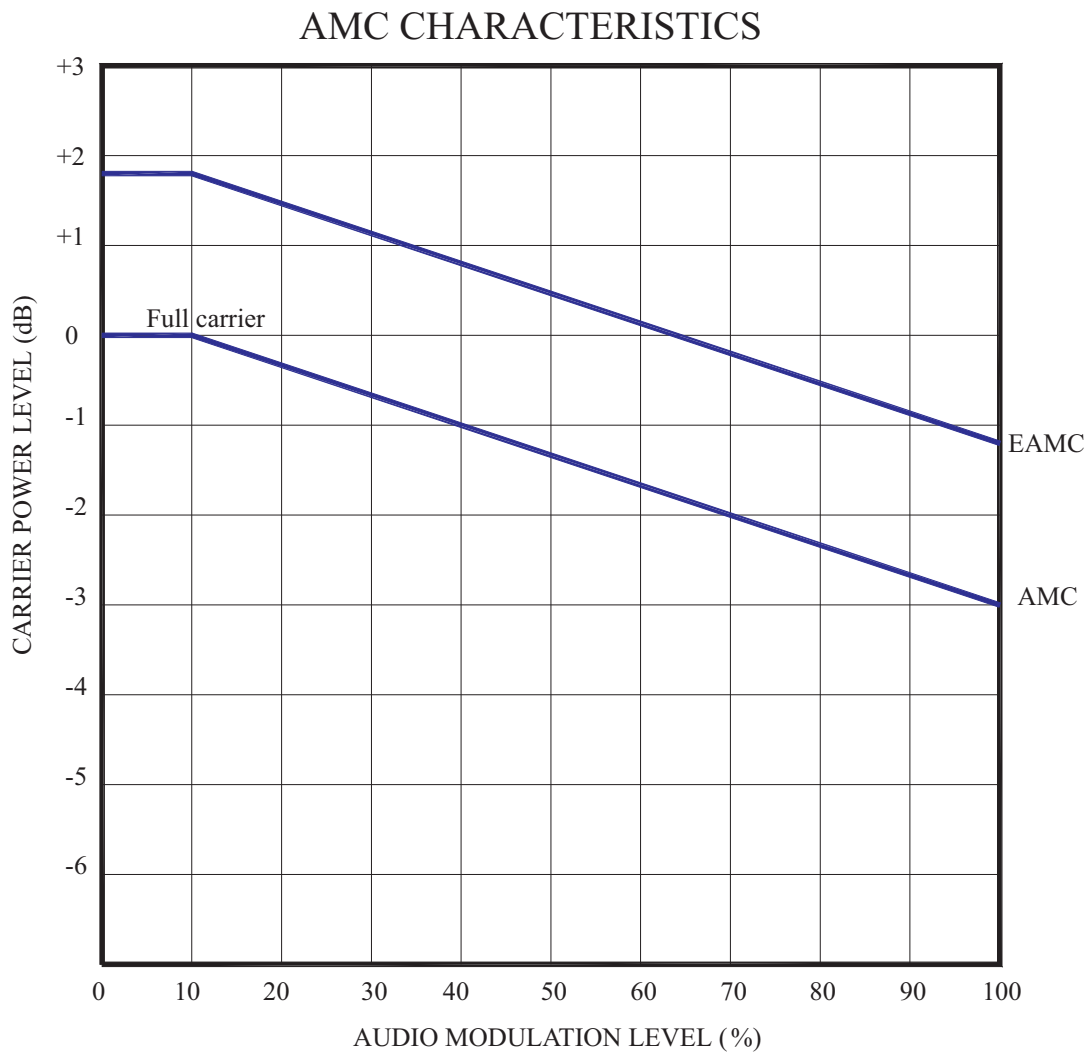

Figure 1-1
AMC+ Characteristics Curve Graph

1.2.1.2 Power Savings

Due to the highly dynamic nature of typical programming, it is difficult to predict actual power savings. However, some stations have performed AMC+ tests on transmitters and reported as much as a 35% savings in power consumption over a non-AMC+ transmitter with no perceptible difference in audio quality or reception range.

1.2.1.3 Conclusion

AMC+ represents improved ways to reduce energy consumption and reduce operating cost. It can be used with our already highly efficient 3DX transmitters without effecting listener pleasure or disturbing the coverage area.

1.3 Block Diagram

The AMC+ system is contained on a PC board that is mounted inside the transmitter. Program audio is applied to the AMC+ board and then connected to the transmitter audio input. A carrier sample from the oscillator is required for synchronization of the system. The power supplied required by the AMC+ circuit board is supplied by the transmitter's internal power supplies.

1.4 Specifications

The following is a listing of the specifications for this unit.

1.4.1 Reduction Accuracy

Accuracy: +/-0.5dB carrier reduction accuracy when properly aligned.

1.4.2 Squarewave Overshoot

With AMC+ enabled, 3% maximum.

1.4.3 AMC+ Operation

AMC+ On/Off selectable by local toggle switch or by ground sink remote control.

1.4.4 Audio Input Level

Normally +10 dBm for 100% modulation.

1.4.5 Audio Input Impedance

Balanced input with selectable 600 Ohm or high impedance.

1.4.6 Audio Input Connector

ACC board, J10, pins 1(+), 2(shield), and 3(-).

⇒ **NOTE:**
Specifications subject to change without notice.

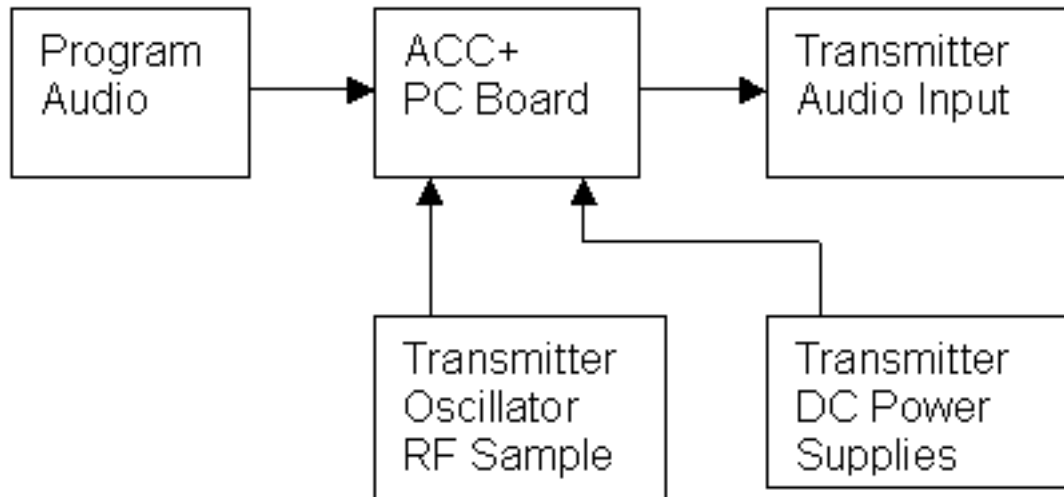

Figure 1-2
Simple Block Diagram of the AMC+ System

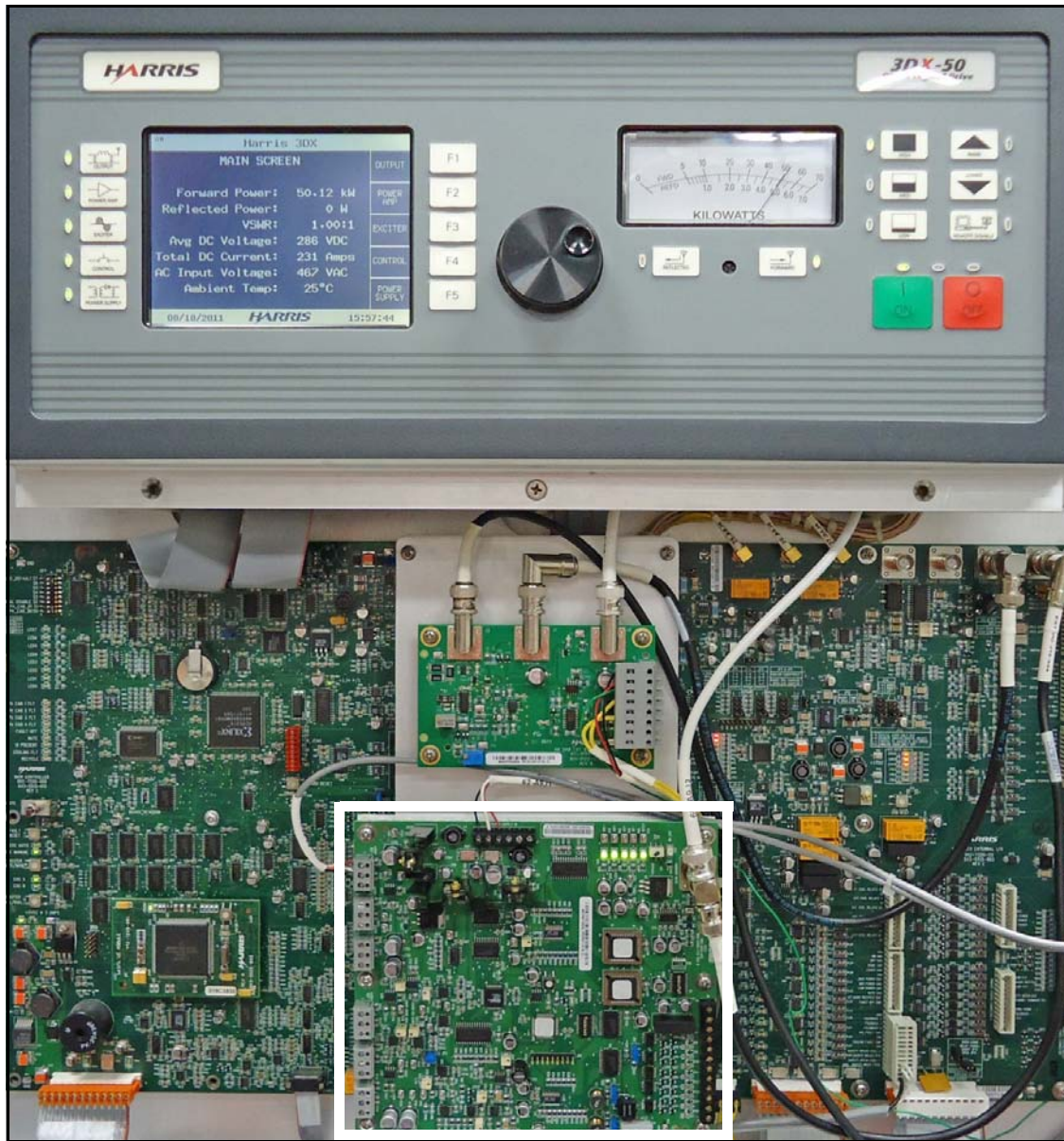

Figure 1-3
AMC+ Board Installed in 3DX-50

Section 2

Installation

2

2.1 Introduction

This section provides information and instructions necessary for the installation and initial turn-on of the AMC+ Amplitude Modulation Companding board in a 3DX-25 or 3DX-50.

2.2 Returns And Exchanges

Damaged or undamaged equipment should not be returned unless a written Return Authorization is issued. When communicating with Harris Corporation, Broadcast Division, specify the order number or invoice number. Include complete details regarding circumstances and reasons for return in the request. Custom equipment or special order equipment is not returnable. In instances where return or exchange of equipment is at the request or convenience of the customer, a restocking fee will be charged. Special shipping instructions and coding will be provided to insure proper handling. All returns will be sent freight prepaid and properly insured by the customer.

2.3 Unpacking

If AMC+ is not already installed in the transmitter, carefully unpack the unit and save all packing material. Inspect thoroughly for any damage incurred in shipment. Retain all PACKING CHECK LISTS (if provided) to locate and identify any components or assemblies removed for shipping.

2.4 Installation

This section provides the information necessary to install and verify performance of the AMC+ Amplitude Modulation Companding system in a 3DX-25 or 3DX-50 transmitter.

⇒ NOTE:

See "Figure 3-1 Component Locator" on page 3-3. See Table 6-1 on page 6-2 for a listing of testpoints jumpers LEDs and potentiometers.

The Harris part number of the AMC+/ACC+ Installation Kit for the 3DX transmitter is 992-7285-064. The kit contains:

- a. AMC+ PC board
- b. ACC+, AMC+ Software/Firmware
- c. Enhanced External I/O PC board
- d. Mounting plate with mounting hardware
- e. Audio cables
- f. DC power cable
- g. RF sync cable
- h. Adjustment tools
- i. AMC+ and Enhanced External I/O Documentation Packages

2.4.1 Test Equipment Needed for Installation

The following test equipment is needed to install the AMC+ circuit and verify its performance:

- a. Audio generator
- b. Oscilloscope or modulation monitor
- c. Spectrum analyzer (optional)

2.4.2 Mechanical Installation

⇒ NOTE:

This installation procedure assumes the presence of an AM DAB External Switch w/PLL Board, Harris Part Number 901-0122-121G, included standard in all units as of June 2011. A Field Installation Kit, Harris part number 773-5000-

004/Service Bulletin AM-589-LM, is available upon request. If your unit does not have this board, contact Harris Radio Field Service. Refer to Interconnect Diagram, 843-5523-883, for the following connections.

- a. Turn transmitter off and remove low voltage.
- b. Attach 2 standoffs, (one standoff each), to the Main Controller (top right corner) and Enhanced External I/O (top left corner) boards.
- c. Relocate the AM DAB EXT Switch w/PLL board and mounting plate pictured in Figure 1-4, to the top 4 standoffs, as in figure 1-3.

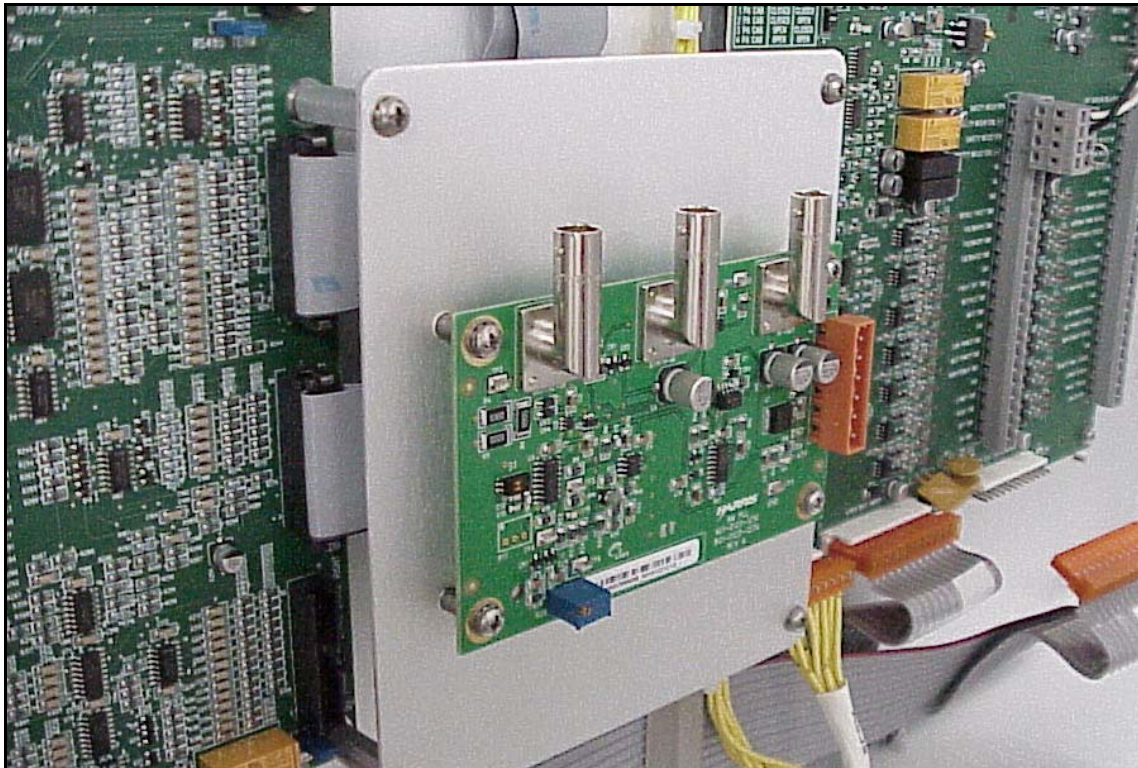

Figure 2-1
Typical AM DAB Switch with PLL Board Location

- d. Attach AMC+ board mounting plate, overlaying the center, and to the lower standoffs.
- e. Install AMC+ board to the lower mounting plate using supplied hardware.
- f. Connect the supplied cables from the AMC+ board to the Enhanced I/O for DC Power and Audio.
- g. Add the supplied BNC TEE connector to the ACC+ board's Carrier Input J2.

- h. Using the supplied coax cable kit, connect wire #60 from the BNC TEE connector to the AM DAB EXT Switch w/PLL board's RF Out (J2). Then with wire #304 connect the BNC TEE connector to the Enhanced I/O board's RF Carrier In (J12).

2.5 Initial Settings

This section provides the information necessary to preset jumpers, switches, potentiometers and settings prior to alignment.

2.5.1 Enhanced External I/O Board Configuration

⇒ NOTE:

Refer to the Transmitter's Technical Manual/Appendix A for the Enhanced External I/O board and drawing #843-5513-901, for further jumper selection details.

On the **Enhanced External I/O board** ensure the following:

- a. Jumper JP1 IN

⇒ NOTE:

JP1 is for 50 Ohm or high input impedance at External 10 Mhz Reference In J10. JP1 can be selected as IN or OUT as needed for corresponding external reference source impedance.

- b. Jumpers JP2 and JP4 IN

⇒ NOTE:

JP2 and JP4 IN allow for 600 Ohm audio input impedance.

- c. Jumpers JP3 and JP6 IN

⇒ NOTE:

JP3 and JP6 allow a DC coupled audio input.

- d. Jumper JP5 OUT

⇒ NOTE:

JP5 OUT allows a high impedance input at J12, the external RF carrier input.

- e. Jumper JP7 is 2-3 (see note below step g.)

f. Jumper JP8 is 2-3

⇒ NOTE:

JP8 2-3 sets audio input or built-in test waveform source selection to audio input.

g. Jumpers JP9, JP10 and JP11 are 1-2

⇒ NOTE:

Jumpers JP9, JP10, and JP11 select the audio input filter bandwidth. Bypassing of the adjustable low-pass filter with JP7 2-3 flat (or selection of filter IN and 50 kHz bandwidth with JP9, JP10, and JP11) is required for operation with DRM or HD Radio compliant external modulators.

h. Jumper JP12 IN

⇒ NOTE:

JP12 can be sine or triangular wave generator output, user selectable.

i. Jumper JP13 1-2

⇒ NOTE:

JP13 can be 1-2 for Analog audio only, 3-4 for switching to analog upon an AES error, 5-6 for remote analog/digital audio selection, or 7-8 for digital audio only operation.

j. Jumper JP14 1-2

⇒ NOTE:

JP14 selects the audio input with 1-2 for left audio input, 3-4 for right, and 5-6 for Mono, with a Monaural Gain Adjust R58.

k. Jumper JP15: Out

⇒ NOTE:

JP15 IN or closed enables an RS-485 for a second cabinet. JP15 OUT or open disables the RS-485 receiver. JP15 should be out to avoid an ARC fault led indication and transmitter RF mute.

l. Jumper JP16 IN and JP17 OUT

⇒ NOTE:

JP16 IN provides 10 k pull-up on external status outputs to an isolated +5 vdc supply. JP17 IN ties common ground to the isolated supply's ground (b ground).

- m. Select S2-1 and S2-2 to the closed position.
- n. Turn R34 fully CCW.
- o. Using the supplied connectors, make connection of the external safety interlocks at J21-9 and 10, and J21-11 and 12.

⇒ NOTE:

External connection of safety interlocks must be made for the transmitter to turn ON.

- p. Reapply low voltage to the transmitter.
- q. Set the 3DX transmitter's ACC ON/OFF control on the ¼ VGA Display to ACC "ON". Go to exciter screen and press F3 and F4 simultaneously. Use the scroll knob to highlight ACC. Press knob to highlight the setting, turn until ACC is "ON", then press knob again.

⇒ NOTE:

With operation of the AM DAB EXT Switch w/PLL Board, the Carrier should be set to external (EXT) source. External carrier selection is a normal setup step when adding an external modulator. For more information about installation of an external modulator or RF Source, consult the transmitter technical manual. If source is not set to external, use the scroll knob to highlight Int/Ext RF Carrier. Press knob and turn until "EXT" is displayed, then press knob again.

2.5.2 AMC+ Board Configuration

⇒ NOTE:

Refer to the AMC+ schematic, drawing 843-5400-771, for further jumper selection details.

- a. Jumper JP1 2-3

⇒ NOTE:

JP1 2-3 allows for high impedance for the carrier input.

- b. Jumper JP2:1-2

⇒ NOTE:

JP2 1-2 allows for remote selection of EAMC+ mode.

- c. Jumper JP3:1-2 and JP4 1-2

⇒ NOTE:

JP3 and 4 1-2 allow for 600 Ohm input impedance for the audio source.

d. JP5: 2-3

⇒ NOTE:

JP5 2-3 allows for inversion/use of the negative audio to drive the peak detector (which generates the dc carrier level), in cases where positive audio is asymmetrically distorted.

e. Turn AMC+ off or bypassed, with switch S2 (Switch is left, DS1 is off).

2.5.3 Select AMC+ Curve (S1)

Only one curve is available with the AMC + Scheme of carrier reduction. All switches for S1 should be in the zero state (ON, or to the left) See Figure 2-2 on page 2-7.

For optimum AMC+ performance, the audio must be delayed by 1mS on this board. With dual channel oscilloscope probes on TP8 and TP12, you can verify the delay of 1mS after the following switch settings have been made, *and the CPLD has been reset.*

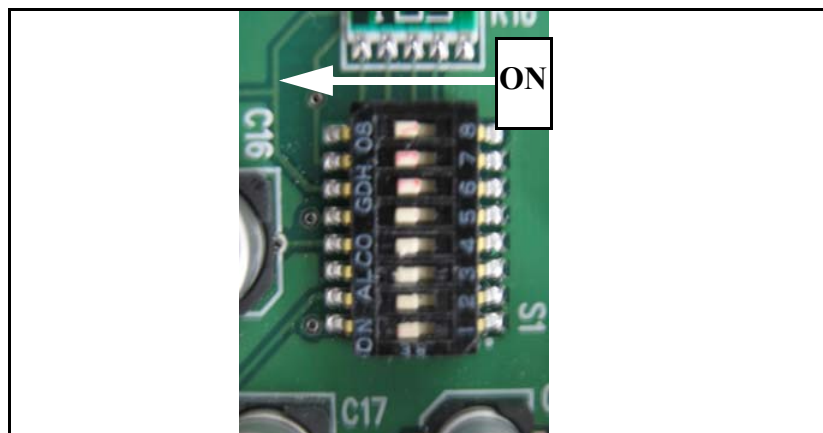

Figure 2-2
S1 Shown With All Switches Closed ("Zero"/ON)

⇒ NOTE:

0 means the switch is closed, or in the ON position (switch is in the DOWN position when viewed with the BNC connector at the top left corner as installed).

1 means the switch is open or in the OFF position (switch is in the UP position when viewed with the BNC connector at the top left corner as installed).

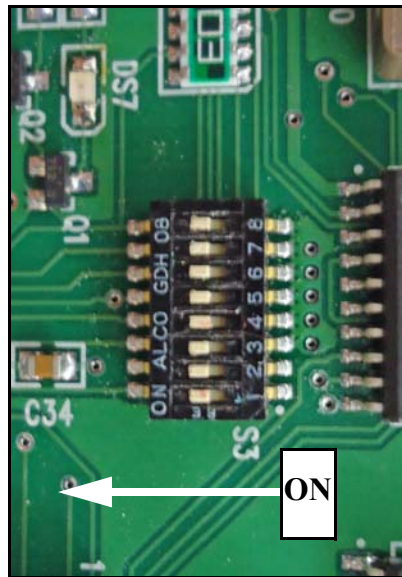

Figure 2-3
S3 Shown With All Switches Closed ("Zero"/ ON)

When looking at the board with the J2 BNC connector on the right near the top corner, S3-8 is on the top, and S3-1 is at the bottom. The switch should be clearly marked see Figure 2-3.

Using the dipswitch weighting listing *below*, divide each by your carrier frequency to determine the individual delays for each position. Then determine which switches will need to be enabled to provide the total 1mS delay for your carrier frequency.

- S3- 1 = 8192
- S3- 2 = 4096
- S3- 3 = 2048
- S3- 4 = 1024
- S3- 5 = 512
- S3- 6 = 256
- S3- 7 = 128
- S3- 8 = 64



NOTE:

The CPLD must be reset in order for the changes of S3 to become active. To do this, press S4 on the AMC+ board after you change the settings of S3.

Example:

Using the table below that was created *based on a carrier frequency of 1089kHz*, the added delays of switches #4 and #8 create a total delay of 0.999mS. This is the closest value, to 1mS, attainable with this switch configuration.

⇒ NOTE:

It is better to be slightly over 1mS, than under.

Table 2-1 Example Phase Delay Chart

S3	Weighting	Carrier Frequency	Delay (mS)
1	8192	1089000	7.522
2	4096	1089000	3.761
3	2048	1089000	1.881
4	1024	1089000	0.940
5	512	1089000	0.470
6	256	1089000	0.235
7	128	1089000	0.118
8	64	1089000	0.059

2.6 AMC+ Setup for 3DX Transmitters

This section provides alignment information for the ACC+, Adaptive Carrier Control board, with AMC+ (Amplitude Modulation Comanding) version IC's U9 and U10, Harris Part Number 917-2332-719.

The AMC+ board is aligned in the factory, however it will require field adjustment for frequency selection. Also, in the event the AMC+ board requires replacement, this section is intended to provide guidance to establish AMC+ board level alignment.

⇒ NOTE:

See the Component Locator Figure 3-1 on page 3-3, to help locate potentiometers and testpoints for the procedures below. Also see Table 6-1 on page 6-2 for a listing of testpoints, jumpers, LEDs and potentiometers.

- a. Connect audio input and audio output to/from the audio generator.
- b. Set audio generator output level to 10dBm for 600 Ohms, audio frequency @ 1kHz.
- c. Turn audio generator output on.
- d. Turn transmitter low voltage on.
- e. If not already done, set dipswitch S1-1 through S1-8 to 0000000 (On - left - is "0")
- f. Insure S2 set to ACC mode OFF (Switch is LEFT, DS1 is off).
- g. Monitor TP16 with an oscilloscope and adjust R76 until the peak to peak voltage is 7.60V.
- h. Monitor TP8 with an oscilloscope and adjust R64 until the peak to peak voltage is 1V.
- i. Monitor TP12 with an oscilloscope and adjust R68 until the peak to peak voltage is 7.0V.
- j. Monitor TP11 with a digital voltmeter (with negative on chassis ground) and adjust R78 for $5.0 \pm 0.02V$.
- k. Adjust R119 fully counter clockwise (CCW).
- l. Adjust R121 fully clockwise (CW).
- m. Using an oscilloscope, set a zero volt DC reference on the display and monitor TP20. *With the scope probe DC coupled*, adjust R105 until the bottom of the sine wave touches the zero reference level on the scope. It may be helpful to amplify the signal on the scope for ease of adjustment.
- n. While monitoring TP20 with an oscilloscope, adjust R113 until the peak to peak voltage is 0.8V.

- o. Switch S2 to ACC mode ON (Switch is RIGHT, DS1 is on)
- p. While monitoring TP20 with an oscilloscope, adjust R104 until the bottom of the sine wave touches the zero reference level on the scope. It may be helpful to amplify the signal on the scope for ease of adjustment.
- q. While monitoring TP20 with an oscilloscope, adjust R119 clockwise for a peak to peak voltage of 0.6V.
- r. Switch S2 to ACC mode OFF (Switch is LEFT, DS1 is off).
- s. Select HIGH Power
- t. Turn transmitter on and slowly raise power control to maximum while ensuring transmitter does not *exceed* desired power level.

⇒ NOTE:

If the transmitter attains the desired output, and still has excess raise control, it will be necessary to reduce the carrier using R113 (adjust counter clockwise).

- u. Once the proper power level is attained, push and hold HIGH (until a beep is heard) to save and store this power setting.
- v. Switch to MEDIUM Power and adjust medium power to level to the desired power level.
- w. Once the proper power level is attained, push and hold MEDIUM (until a beep is heard) to save and store this power setting.
- x. Switch to LOW Power and adjust the RAISE power control to the desired power level.
- y. Once the proper power level is attained, push and hold LOW (until a beep is heard) to save and store this power setting.
- z. Select HIGH Power.
- aa. Use R105 and R113 and make the adjustment to produce the desired power level and 100% modulation exactly.

⇒ NOTE:

R105 and R113 interact.

R105 counter clockwise causes carrier level to decrease and modulation to increase, while clockwise causes carrier level to increase and modulation to decrease.

R113 counter clockwise causes carrier level to decrease, and clockwise causes carrier level to increase, while having no significant effect on modulation.

- ab. Switch S2 to ACC mode ON (Switch is LEFT, DS1 is on)
- ac. Use R104 and R119 to match half (3dB power reduction) of desired power level and 100% modulation exactly.

⇒ NOTE:

R104 and R119 interact.

R104 counter clockwise causes carrier level to decrease and modulation to increase, while clockwise causes carrier level to increase and modulation to decrease.

R119 counter clockwise causes carrier level to decrease, and clockwise causes carrier level to increase, while having no significant effect on modulation.

- ad. Remove modulation and ensure full desired output power. Minor re-adjustment to R104 and R119 to satisfy both the conditions of; *with* 10 dBm audio, and *without* audio.
- ae. As a final step, using program modulation, toggle between ACC ON and OFF while observing negative modulation. Turn R104 slightly (for example, counter clockwise will decrease the modulation level but will also increase the carrier level), then adjust R119 (for example, counter clockwise to lower the carrier level) back to the desired power level.

⇒ NOTE:

To aid in final alignment.

The following list is a description of what mode and the affect adjusting the 4 most important potentiometers have on carrier level and modulation.

- **ACC OFF**
R105 DC Offset:
 CCW causes Carrier level to decrease and Modulation level to increase
 CW causes Carrier level to increase and Modulation level to decrease
- **ACC Operate Mode**
R104 DC Offset:
 CCW causes Carrier level to decrease and Modulation level to increase
 CW causes Carrier level to increase and Modulation level to decrease
- **ACC Operate Mode**
R119 Audio+DC Trim
 CCW causes carrier level to decrease
 CW causes carrier level to increase
- **ACC ON or OFF (normally aligned with ACC OFF)**
R113 Audio+DC Gain:
 CCW causes Carrier level to decrease
 CW causes Carrier level to increase

This concludes the Alignment of the AMC+ board and it is now ready for verification in a 3DX transmitter.

2.6.1 Initial Turn On

- a. Turn transmitter on HIGH.
- b. Turn AMC+ on with S2 on the AMC+ board (Switch is RIGHT, DS1 is on).

2.6.2 AMC+ Verification

The table below is a quick check for proper AMC+ operation with transmitter ON at the desired power of 10kW:

Table 2-2 AMC+ Operational Check for 10kW Desired Power

Audio %	AMC Bypass (S2)	AMC On (S2)
0%	10kW	10kW
100%	10kW	5kW
0% → 100%	10kW	10kW → 5kW

Further verifying AMC+ is shown below.

- a. Using an oscilloscope and the transmitter's forward power meter; or using a spectrum analyzer and modulation monitor connect the transmitter modulation monitor sample to the equipment described above.
- b. Turn on the program modulation, and record the level of carrier reduction and percentage of modulation.
- c. Verify that the forward power of the transmitter is reduced accordingly with the percentage of modulation (See Figure 1-1 on page 1-4).

⇒ NOTE:

Errors in transmitter forward power metering at reduced powers or spectrum analyzer/modulation monitor calibration, may contribute to inaccuracies.

Section 3

Operation

3

3.1 Introduction

This section contains normal operational procedures and information pertaining to the function of the AMC+ Amplitude Modulation Companding.

3.2 Operation

This operational procedure is presented under the assumption that the controller has been properly installed and checked out as outlined in Section II, Installation/Initial Turn-On, of this manual.

- a. Normal AMC+ Bypass and AMC+ On operation
- b. Identification of all panel controls and indicators

3.2.1 AMC+ Bypass

With the transmitter turned on, and *ACC On/Bypass* switch (S2) set to BYPASS, the forward power meter should show the power level selected and not change significantly with modulation.

3.2.2 AMC+ On

With the transmitter turned on and AMC+ is on (*ACC On/Bypass* switch, S2, set to ON), it is normal to see the carrier power level fluctuate with modulation, and DS1 indicator (*ACC On*) will be illuminated amber (yellow). The amount of carrier power level fluctuation will be determined by the modulation (see Table 2-2 on page 2-13).

3.2.3 Controls and Indicators

Figure 3-1, below, shows the following components' location:

- ON/BYPASS switch S2 (upper right corner of board)
- ON/BYPASS indicator DS1 (upper right corner of board)
- S1 Curve selection
- S3 Phase Delay selection
- J10 Audio Input connector
- JP3 and JP4 Audio Input Impedance selector
- J2 Carrier Input connector
- JP1 Carrier Input Termination selector
- All potentiometers
- J9 Remote Control connector
- J3 - J8 Audio Output connectors
- J1 DC Power Input connector
- DC Power Supply connectors

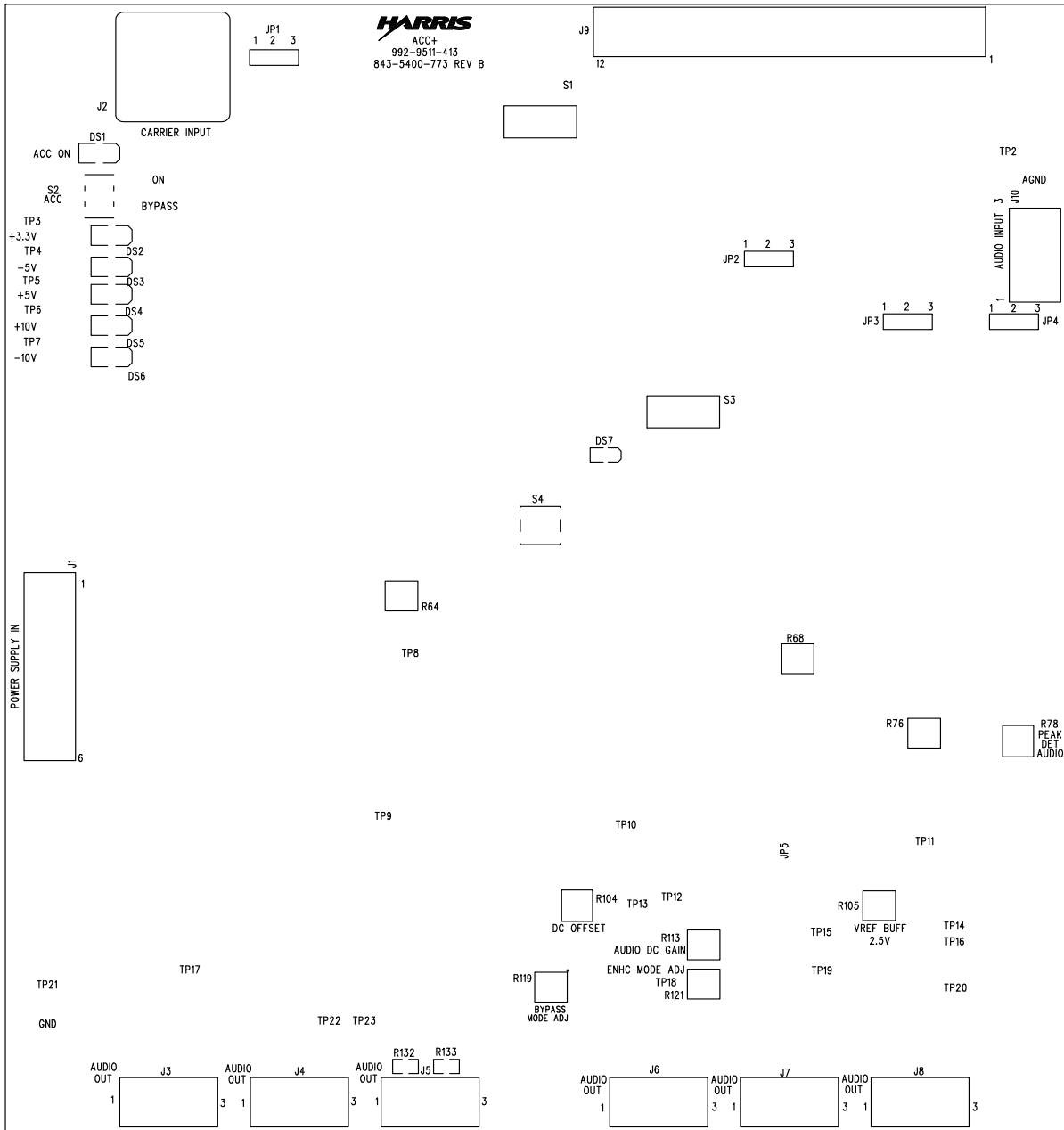

Figure 3-1
Component Locator

Section 4

Theory of Operation

4

4.1 Introduction

This section presents the circuit description of the AMC+ Amplitude Modulation Companding.

Refer to Figure 4-1 Block Diagram and Figure 6-1 on page 6-5, Simplified Schematic.

4.1.1 AMC+ OFF Mode of Operation

The AMC+ mode can be turned OFF by putting S2 in the bypass position. When this is in bypass, the carrier control feature is disabled and the output power of the transmitter will remain steady at the selected power level. DS1 will not be illuminated.

4.1.2 AMC+ ON Mode of Operation

The AMC+ mode can be turned ON by putting S2 in the ACC-ON position. When this mode is ON, the carrier control feature is active and the output power of the transmitter will fluctuate with the % of modulation. DS1 will be illuminated amber.

4.2 Detailed Circuit Description

Refer to the schematic, 843-5400-771 in the back of this technical manual for the following discussion.

4.2.1 Audio Input

Audio input is connected to J10:

J10-1	+ Audio
J10-2	Ground
J10-3	- Audio

The input audio signal is filtered and buffered through a low pass filter and differential op-amp U21. Audio input impedance is selected by JP3 and JP4:

JP3 1-2 & JP4 1-2 = 600 Ohms
JP3 2-3 & JP4 2-3 = High Impedance

The buffered audio signal is then scaled and peak detected, with a fast attack and slow decay peak detector circuit consisting of U25 and U31.

4.2.2 A/D Converter - Look Up Table

The DC level at TP14 is varying according to the audio input level. The peak-detected voltage is converted to a 12-bit digital data by the A/D converter (U16). The 12-bit word is then addressed to the pre-stored Look-Up-Table (LUT) content in the memory devices (U10, U9). The output of the LUT also has 12-bits of resolution.

4.2.3 D/A Converter

The 12-bit data from the LUT is then converted to transmitter's carrier level by the D/A converter (U13). The output is then adjusted by the DC offset control R104 and applied to switch U28.

4.2.4 Phase Delay

The non-sampled audio coming from U21 is fed into a A/D Converter (U14). The Digital out is then fed into a High Speed CMOS D-Type Flip Flop. The outputs of this drive a CPLD where, depending on the S3 settings, it will determine the amount of delay. The output of the CPLD is then fed to a D/A converter. The Output of the D/A then goes thru a DC blocking cap (C130) and then U15. R68 provides the DC Offset. This DC carrier level from U15 and the delayed audio signal are then summed through the opamp U30, with gain adjustment control from R113. This Audio + DC output is then applied to the audio driver.

4.2.5 Carrier Synchronization

All digital circuits are operating synchronously, all of the clock pins are tied to the transmitter's carrier frequency for best performance and minimized inter-modulation products.

A carrier RF sample is obtained by a sample from the Oscillator board. JP1 is normally set 1-2 for a 50 Ohm termination.

4.2.6 Remote Control

The AMC+ board is capable of remote and local selection; it can be programmed with 12-bit dynamic resolution.

J9 is the remote control connection. Remote control selection is activated by ground sync connection and buffered by opto isolator U4. Connecting the appropriate J9 connector to ground will activate the function. When local AMC ON/OFF switch S2 is ON (AMC ON), J9-9 is the command input (active low) that enables or disables the AMC (or EAMC) mode. J9-8 is the command input (active low) that enables the Enhanced AMC mode (EAMC).

NOTE: JP2 must be set to 1-2 in order to enable this command.

4.2.7 Audio+DC Output Driver

The Audio+DC output is then connected to the transmitter's normal audio input through the Audio Driver.

The Audio Driver stage is fanned out to 6 outputs at J3 through J8. Each audio signal pair is buffered by a set of differential driver op-amps. For single transmitter configurations, J3 is typically used:

J3-1	+ Audio
J3-2	Ground
J3-3	- Audio

4.2.8 Power Supplies

Board DC power is normally supplied from the existing DC supplies within the transmitter. Typically a +VDC from the transmitter cabinet's Power Distribution board will be connected to J1-4, and a -VDC will be connected to J1-6.

These supplies are regulated to +10, -10, +5, -5 and +3.3 VDC on the AMC+ board by regulators U1 through U4 and U9. Test points and indicators are provided near the edge of the board as troubleshooting aids.

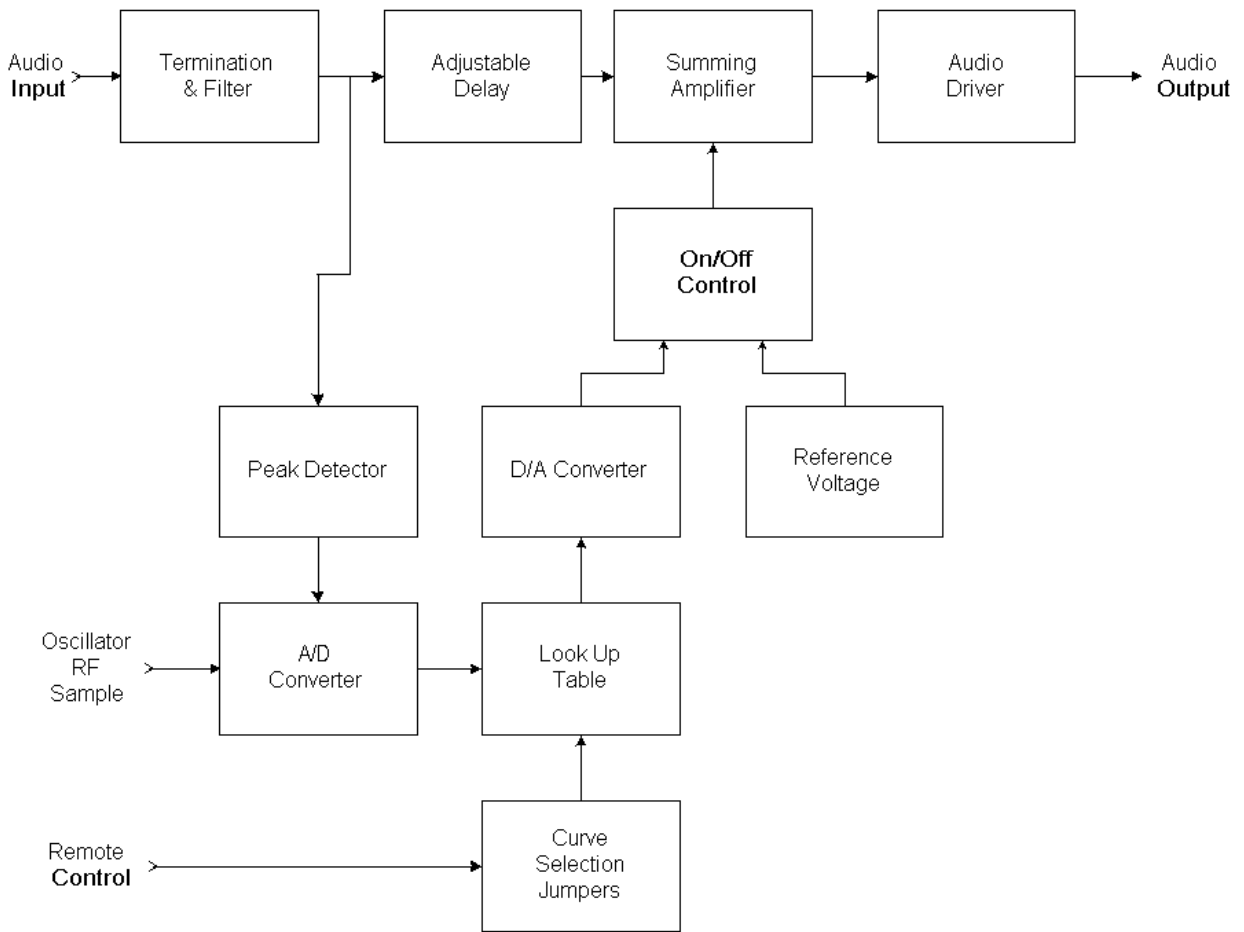

**Figure 4-1
AMC+ Block Diagram**

Section 5

Maintenance and Alignments

5

5.1 Introduction

This section provides alignment information for the ACC+, Adaptive Carrier Control board, with AMC+ (Amplitude Modulation Companding) version IC's U9 and U10, Harris Part Number 917-2332-719.

5.2 Purpose

The AMC+ board is aligned in the factory, however it will require field adjustment for frequency selection. Also, in the event the AMC+ board requires replacement, this section is intended to provide guidance to establish AMC+ board level alignment.

5.3 AMC+ Phase Delay (S3)

See "2.5.3 Select AMC+ Curve (S1)" on page 2-7 for this complete procedure.

5.4 AMC+ Alignment for DX Transmitters

See "2.6 AMC+ Setup for 3DX Transmitters" on page 2-10 for this complete procedure.

5.5 AMC+ Verification Procedure

See " This concludes the Alignment of the AMC+ board and it is now ready for verification in a 3DX transmitter." on page 2-12 for this complete procedure.

Section 6

Troubleshooting

6

6.1 Introduction

Troubleshooting of AMC+ consists of reading this manual and verifying proper installation and alignment. The following can be used as a guide. See Table 6-1 on page 6-2 for a listing of testpoints, jumpers, LEDs, and potentiometers.

6.2 Troubleshooting Hierarchy

6.2.1 Power Supplies

Verify power supplies are present at J1-4 and J1-6, and observe power supply indicators DS2-DS6.

6.2.2 Carrier Sync

Verify Oscillator sample at TP9. A 5Vp-p square wave at carrier frequency should be present.

6.2.3 Jumper Settings

Verify jumper settings are as described in sections 2 and 4 of this manual.

6.2.4 Audio Input/Output

Use an oscilloscope to verify correct audio signal at AMC+ input, J10. Also check for an audio output signal at J3.

6.3 ACC bypass mode

Refer to the AMC+ schematic for jumper arrangements when bypassing the AMC+ function.

In addition to moving the jumper wire to bypass the function the Analog Input (or Audio Input) board in the transmitter must be adjusted.

Refer to the Analog Input board schematic in the transmitter drawing package for specific jumper and potentiometer numbers. Also refer to the transmitter instruction book for the set up procedure of the board.

First the Analog Input board will have to be AC coupled by moving jumpers that were in DC couple mode when using the AMC+ board. The Audio Gain adjustment and Max Power Adjustment will need to be set up with the AMC+ in bypass mode.

6.4 Component Table

The following table displays important testpoints jumpers LEDs and potentiometers.

Table 6-1 Pertinent Testpoints, Jumpers, LEDs, & Potentiometers

Test Point	LED (DS) or Jumper	Pot.	Name / Function	Comment / Value
	DS1		AMC+ On	Illuminates when AMC+ is Enabled
	DS7		Reset	
TP1			Carrier Input	
TP2			GND A	
TP3	DS2		+3.3Vdc	
TP4	DS3		-5Vdc	
TP5	DS4		+5Vdc	
TP6	DS5		+12.7Vdc	
TP7	DS6		-12.7Vdc	
TP8		R64	Non-Sampled Audio	1.0 - 1.2Vp-p

Table 6-1 Pertinent Testpoints, Jumpers, LEDs, & Potentiometers

Test Point	LED (DS) or Jumper	Pot.	Name / Function	Comment / Value
TP9			0.5V P-P	
TP10			Audio DC Offset	
TP11		R78	Audio	+5.0Vdc \pm 0.02Vdc
TP12		R68	Delayed Audio	6.93 - 7.2Vp-p
TP13				
TP14			Peak Detected Audio	
TP15			V Rdf Buffer 2.5Vdc	
TP16		R76	Audio	+7.6Vdc
TP17			Audio Outputs	
TP18			Audio Outputs	
TP19			Audio Outputs	
TP20		R104	Audio Outputs	+0.8Vp-p on zero reference
TP21			GND	
TP22			Audio Outputs	
TP23			Audio Outputs	
		R105		VREF Buffer 2.5Vdc (Non-ACC Carrier Level Adjust)
		R113		Audio+DC Gain Adjust
		R119		ACC On Audio+DC Gain Adjust
		R121		Enhanced Mode Adjust
	JP1		Carrier Input Impedance Select	1-2: 50 Ω Carrier Input 2-3: High Impedance Carrier Input
	JP2		Remote Activation of Enhanced Mode	2-3: Enables Remote Activation of Enhanced Mode

Table 6-1 Pertinent Testpoints, Jumpers, LEDs, & Potentiometers

Test Point	LED (DS) or Jumper	Pot.	Name / Function	Comment / Value
	JP3		Audio Input Impedance Select	1-2: 600Ω Audio Input Impedance 2-3: High Audio Input Impedance
	JP4		Audio Input Impedance Select	1-2: 600Ω Audio Input Impedance 2-3: High Audio Input Impedance
	JP5		Inverted or Non-Inverted Peak Detector	1-2: Positive Audio Detection 2-3: Negative Audio Detection

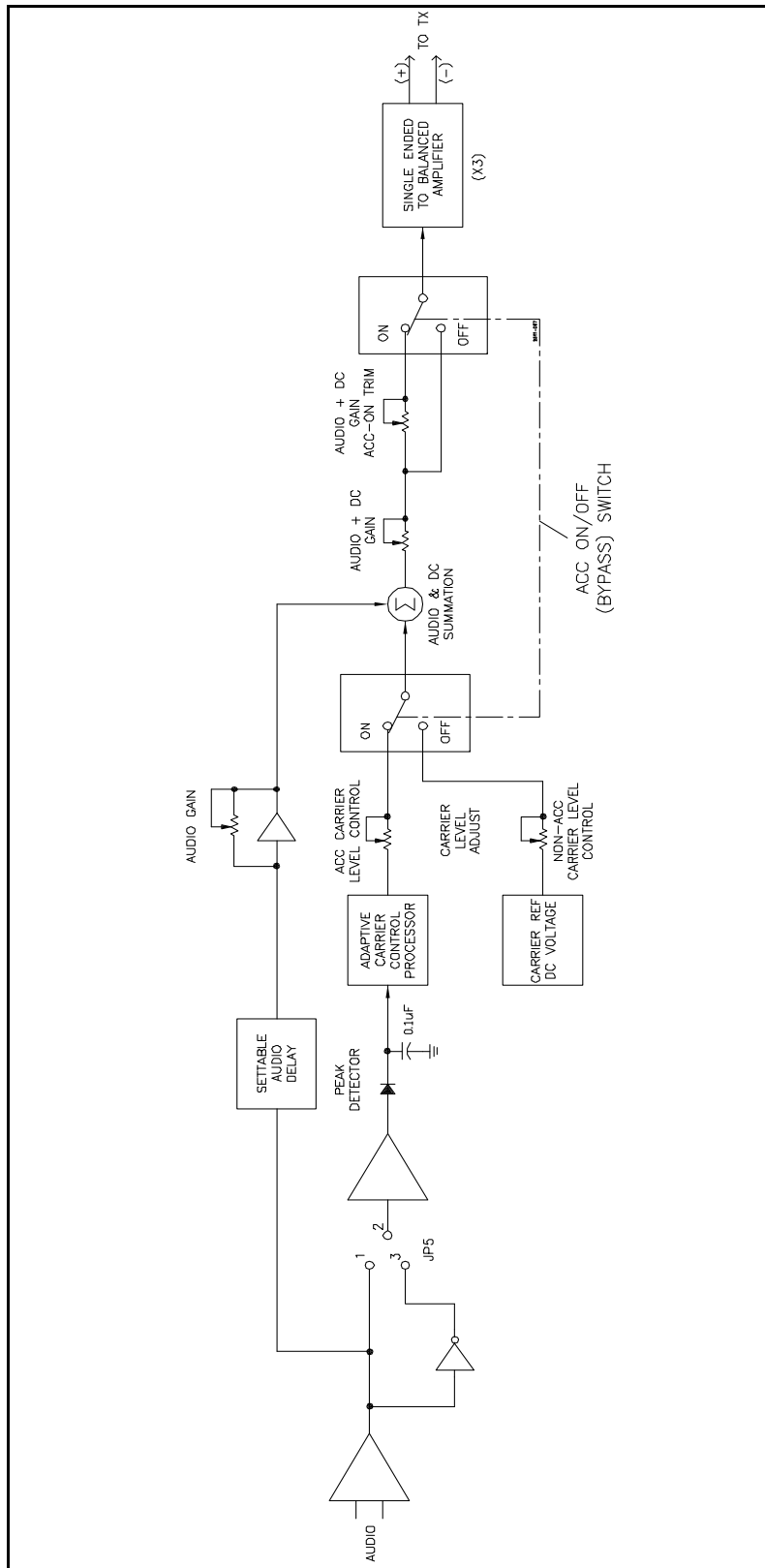

Figure 6-1 Simplified Schematic

Section 7

Parts List

7

7.1 Parts List

Table 7-1	OPT #5, ACC W/ENHANCED EXT I/O - - - - -	992 7285 064 ((F))	7-1
Table 7-2	OPT #4, ENHANCED EXT I/O PKG - - - - -	992 7285 061 (B)	7-1
Table 7-3	ACC+ BOARD - - - - -	992 9764 319 (C)	7-1
Table 7-4	PWA, ACC+ - - - - -	992 9511 413 (G)	7-2

Table 7-1 OPT #5, ACC W/ENHANCED EXT I/O - 992 7285 064 ((F))

Harris PN	Description	Qty UM	Ref Des
302 0108 000	SCR, 6-32 X 1/2	4 EA	
302 0109 000	SCR, 6-32 X 5/8	6 EA	
310 0012 000	WASHER, FLAT #6 SST (ANSI NARROW)	10 EA	
314 0005 000	LOCKWASHER, SPLIT #6 SST (ANSI)	10 EA	
620 0124 000	ADAPTER, BNC-JACK TO BNC-PLUG	2 EA	
620 0300 000	TEE, BNC, UG-274U JACK-PLUG-JACK	1 EA	
813 5000 011	STDOFF 6-32X1 5/16 HEX	4 EA	
813 5604 008	STUD BRS 6-32 X 13/16	4 EA	
888 2509 005	TM, AMC + FOR THE 3DX	1 EA	
917 2332 719	FIRMWARE, AMC+	1 EA	U9 U10
917 2517 339	CABLE KIT, ACC 3DX50	1 EA	
939 8220 450	PLATE, ACC BOARD	1 EA	
992 7285 061	OPT #4, ENHANCED EXT I/O PKG	1 EA	
992 9764 319	ACC+ BOARD	1 EA	3A4A9

Table 7-2 OPT #4, ENHANCED EXT I/O PKG - 992 7285 061 (B)

Harris PN	Description	Qty UM	Ref Des
612 2156 012	PLUG, 12C 1ROW VERTICAL	9 EA	
988 2509 001	DOC PKG, ENHANCED EXT I/O	1 EA	
992 7220 113	PWA, ENHANCED EXTERNAL I/O	1 EA	3A5

Table 7-3 ACC+ BOARD - 992 9764 319 (C)

Harris PN	Description	Qty UM	Ref Des
646 2110 000	BARCODE, SN_ITEM_REV	1 EA	
917 2332 718	FIRMWARE, ACC+	1 EA	U9 U10
992 9511 413	PWA, ACC+	1 EA	

Table 7-4 PWA, ACC+ - 992 9511 413 (G)

Harris PN	Description	Qty UM	Ref Des
404 0908 000	*HEATSINK, VERTICAL, TO-220	3 EA	XU18 XU26 XU33
522 0588 000	CAP 100UF 25V 20% 8MM NON-POLAR	1 EA	C130
610 1069 000	HDR, 9C 1ROW VERTICAL UNSHR	1 EA	J99
612 1184 000	JUMPER SHUNT, 2C, 0.1" PITCH	5 EA	XJP1 XJP2 XJP3 XJP4 XJP5
646 2110 000	BARCODE, SN_ITEM_REV	1 EA	
817 2551 014	PROGRAMMING INSTR, ACC/DELAY	0 DWG	#U16
614 0953 005	*TERMINAL STRIP, 6 TERM	1 EA	J1
620 1677 000	JACK, BNC STRAIGHT PCB	1 EA	J2
614 0909 000	TERM BLK, PCB, 3-POLE, GREY (237)	7 EA	J3 J4 J5 J6 J7 J8 J10
614 0953 006	*TERMINAL STRIP, 12 TERM	1 EA	J9
610 0900 000	HDR, 3C VERT 1ROW UNSHR	5 EA	JP1 JP2 JP3 JP4 JP5
382 1633 000	IC, LT1033 ESD	1 EA	U33
382 1328 000	IC, 1085 ESD	1 EA	U18
382 0184 000	*IC, LM340A/LM7805AC (TO-220)	1 EA	U26
566 0037 000	CONVERTER, DC/DC 5V .75W ESD	1 EA	U3
992 9511 414	PWA, ACC+ SMT	1 EA	
843 5400 771	SCH, ACC+	0 DWG	